







ST 050 304 4360



- Ausladung Standbrause 420 mm
- Regenbrause Ø 200 mm
- Regenbrause mit Antikalk-System
- Durchfluss Regenbrause max. 14 l/min (bei 3 Bar)
- Funktion ab: 8 l/min
- Drehumstellung Standbrause/ Handbrause
- Höhe Armatur bis Regenbrause (Unterkante) 985 mm
- Höhe Armatur bis Oberkante Bogen 1160 mm
- zweiteilige Schubrosetten Ø 65 mm
- Rosette für Brausehalter Ø 65 mm
- Rosette für Wandbefestigung Ø 60 mm
- Stichmaß 150 mm ± 13 mm
- Metallbrauseschlauch 1250 mm mit integriertem Verdrehschutz
- Anschluss 1/2"
- Rohrdurchmesser 20 mm

	Chrom	ST 050 304 4360-00
	Platin gebürstet	ST 050 304 4360-06
	Platin	ST 050 304 4360-08
	Messing (23kt Gold)	ST 050 304 4360-09
	Messing gebürstet (23kt Gold)	ST 050 304 4360-28
	Dark Platinum gebürstet	ST 050 304 4360-99





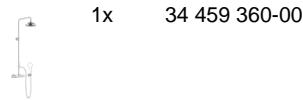

Einzelkomponenten dieses Sets

Für dieses Set benötigen Sie folgende Komponenten



ST 050 304 4360



	Chrom	11 420 360-00
	Platin gebürstet	11 420 360-06
	Platin	11 420 360-08
	Messing (23kt Gold)	11 420 360-09
	Messing gebürstet (23kt Gold)	11 420 360-28
	Dark Platinum gebürstet	11 420 360-99

ST 050 304 4360

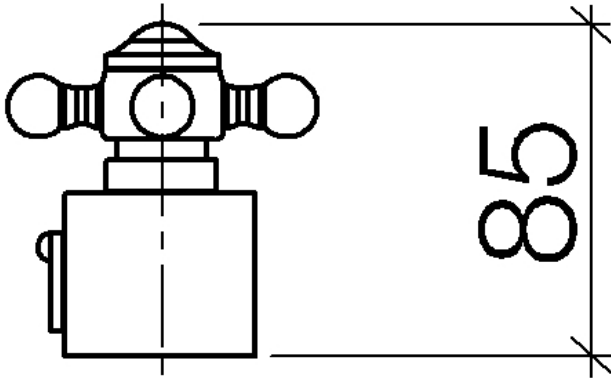

ST 050 304 4360

Ersatzteile für die
anderen
Oberflächenvarianten
finden Sie hier: Platin
gebürstet

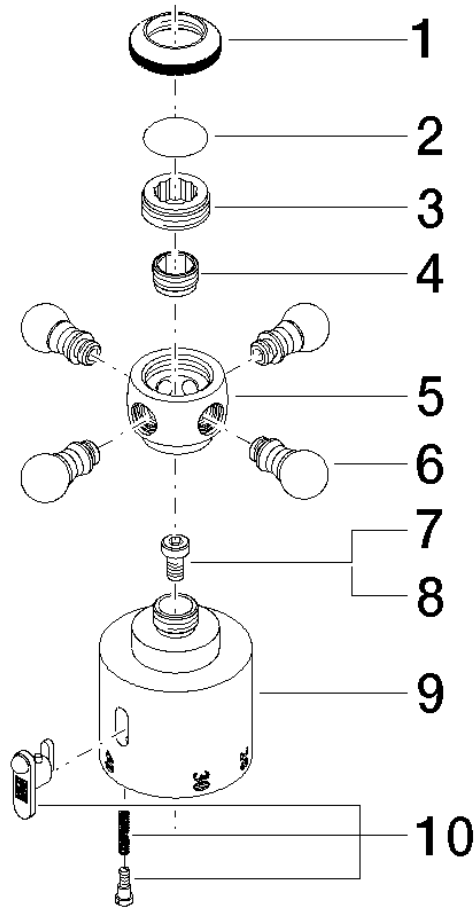







Ersatzteilstückliste

Nr.	Artikelnummer	Benennung	Verbaumenge	Lieferzeit
1	09 20 36 005-00	Griff	1	10
2	09 26 01 016 90	Zubehoer	1	2
3	09 20 83 006 90	Griff	1	2
4	09 24 03 119 90	Nippel	1	2
6	09 20 36 004-00	Griff	4	10
7	90 30 30 027 00 90	Schraube	1	2
8	09 30 33 004 90	Schraube	1	2
10	90 21 33 020 00 90	Griff	1	2

ST 050 304 4360



- Ausladung Standbrause 420 mm
- Regenbrause Ø 200 mm
- Regenbrause mit Antikalk-System
- Durchfluss Regenbrause max. 14 l/min (bei 3 Bar)
- Funktion ab: 8 l/min
- Drehumstellung Standbrause/ Handbrause
- Höhe Armatur bis Regenbrause (Unterkante) 985 mm
- Höhe Armatur bis Oberkante Bogen 1160 mm
- zweiteilige Schubrosetten Ø 65 mm
- Rosette für Brausehalter Ø 65 mm
- Rosette für Wandbefestigung Ø 60 mm
- Stichmaß 150 mm ± 13 mm
- Metallbrauseschlauch 1250 mm mit integriertem Verdrehenschutz
- Anschluss 1/2"
- Rohrdurchmesser 20 mm

	Chrom	34 459 360-00
	Platin gebürstet	34 459 360-06
	Platin	34 459 360-08
	Messing (23kt Gold)	34 459 360-09
	Messing gebürstet (23kt Gold)	34 459 360-28
	Dark Platin gebürstet	34 459 360-99

Dieser Artikel enthält keine Handbrause!

Eigensicher gegen Rückfließen.

ACHTUNG: Die Griffe müssen separat zu den Armaturen bestellt werden!

ST 050 304 4360

1:10

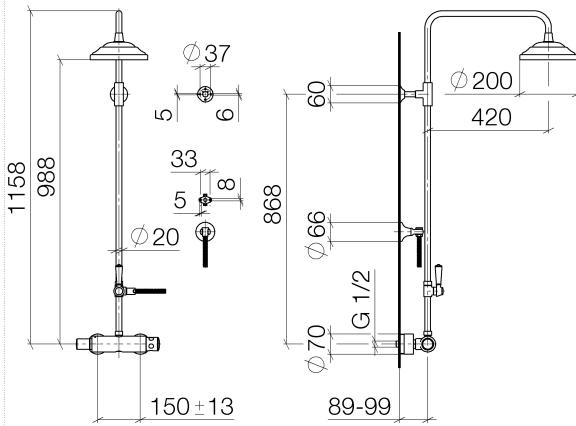

Durchflussdiagramm

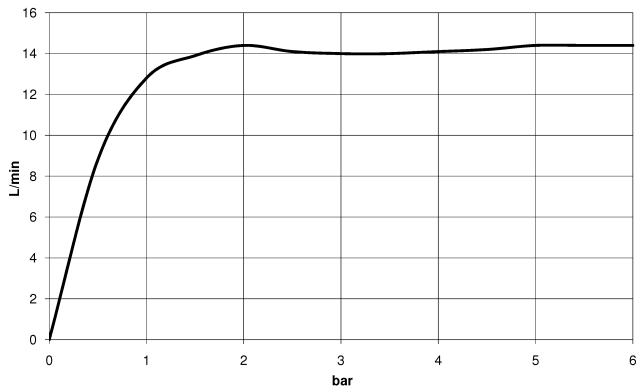

Zertifikate

LGA_38665.

ST 050 304 4360

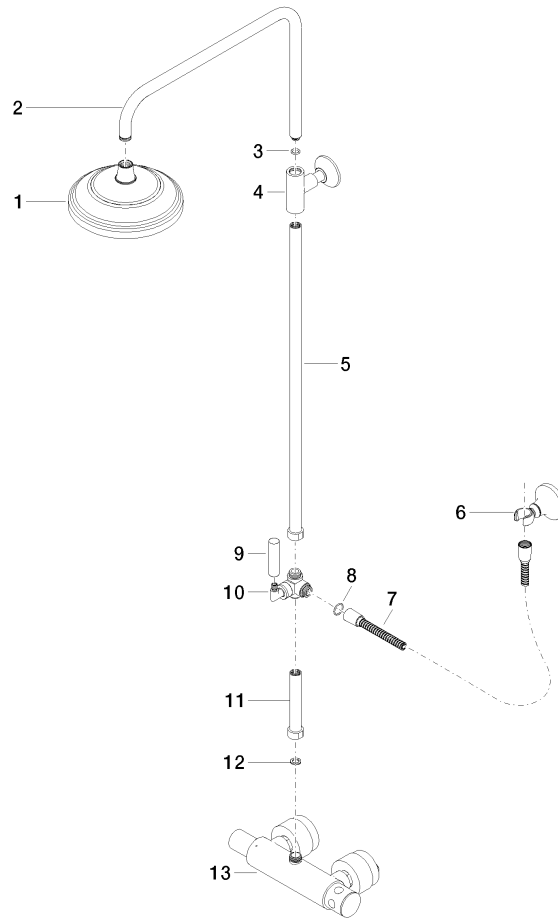

Ersatzteilstückliste

Nr.	Artikelnummer	Benennung	Verbaumenge	Lieferzeit
1	04 12 05 038 01-00	Brause	1	60
2	04 28 22 101 20-00	Auslauf	1	10
3	90 14 10 011 00 90	Dichtung	1	2
4	90 17 11 037 01-00	Halter	1	10
5	90 28 22 104 00-00	Rohr	1	10
6	28 050 410-00	Halter	1	60
7	28 104 970-00	Metall-Brauseschlauch 1/2" x 1/2" x 1250 mm - Chrom	1	2
8	09 14 10 122 90	Dichtung	1	2
9	11 170 370-00	MADISON Hebeleinsatz - Chrom	1	10
10	90 17 09 045 01-00	Umstellung	1	10
11	90 28 22 103 00-00	Rohr	1	10
12	90 14 20 002 00 90	Dichtung	1	2
13	04 17 01 044 01-00	Armatür	1	10